



## DIGITAL WIRELESS INSTRUMENT SET

- I. MR-24GE Wireless Electric Guitar / Electric Bass Set
- II. MR-24GA Wireless Acoustic Guitar Set
- III. MR-24UC Wireless Ukulele Set
- IV. MR-24SS/SA/ST/SB Wireless Saxophone Set
- V. MR-24DC Wireless Cajon Set

### User Guide





## ! IMPORTANT SAFETY INSTRUCTIONS !

1. Read these instructions.
2. Keep these instructions.
3. Heed all warnings.
4. Follow all instructions.
5. Do not use this apparatus near water.
6. Clean only with a dry cloth.
7. Do not block any ventilation openings. Install in accordance with the manufacturer's instructions.
8. Do not install near any heat sources such as radiators, heat registers, stoves, or other apparatus (including amplifiers) that produce heat.
9. Do not defeat the safety purpose of the polarised or ground plug: A polarised plug has two blades with one wider than the other. The wide blade is provided for your safety. When the provided plug does not fit into your outlet, consult an electrician for replacement of the obsolete outlet.
10. Protect the power cord from being walked on or pinched particularly at plug, convenience receptacles, and the point where they exit from the apparatus.
11. Only use attachments/accessories specified by the manufacturer.
12. Use only with a cart, stand, tripod, bracket, or table specified by the manufacturer, or sold with the apparatus. When a cart is used, use caution when moving the cart/apparatus combination to avoid injury from tip-over.
13. Unplug this apparatus during lightning storms or when unused for long periods of time.
14. Refer all servicing to qualified service personnel. Servicing is required when the apparatus has been damaged in any way, such as power-supply cord or plug is damaged, liquid has been spilled or objects have fallen into the apparatus, the apparatus has been exposed to rain or moisture, does not operate normally, or has been dropped.
15. To reduce the risk of fire or electric shock, do not expose this apparatus to rain or moisture.
16. Apparatus should not be exposed to dripping or splashing and no objects filled with liquids, should be placed on the apparatus.
17. Use only with the battery which specified by manufacturer.
18. The power supply cord set is to be the main disconnected device.



## MR-24+MT-24

### Federal Communication Commission Interference Statement

This equipment has been tested and found to comply with the limits for a Class B digital device, pursuant to Part 15 of the FCC Rules. These limits are designed to provide reasonable protection against harmful interference in a residential installation. This equipment generates, uses and can radiate radio frequency energy and, if not installed and used in accordance with the instructions, may cause harmful interference to radio communications. However, there is no guarantee that interference will not occur in a particular installation. If this equipment does cause harmful interference to radio or television reception, which can be determined by turning the equipment off and on, the user is encouraged to try to correct the interference by one of the following measures:

- ! Reorient or relocate the receiving antenna.
- ! Increase the separation between the equipment and receiver.
- ! Connect the equipment into an outlet on a circuit different from that to which the receiver is connected.
- ! Consult the dealer or an experienced radio/TV technician for help.

FCC Caution: To assure continued compliance, any changes or modifications not expressly approved by the party responsible for compliance could void the user's authority to operate this equipment. (Example - use only shielded interface cables when connecting to computer or peripheral devices).

This device complies with Part 15 of the FCC Rules. Operation is subject to the following two conditions: (1) This device may not cause harmful interference, and (2) This device must accept any interference received, including interference that may cause undesired operation.

## MT-24

### FCC Radiation Exposure Statement

This equipment complies with FCC RF radiation exposure limits set forth for an uncontrolled environment. This equipment should be installed and operated with a minimum distance of 0.5 cm between the radiator and your body.

This transmitter must not be co-located or operating in conjunction with any other antenna or transmitter.

The antennas used for this transmitter must be installed to provide a separation distance of at least 0.5 cm from all persons and must not be co-located or operating in conjunction with any other antenna or transmitter.

### IC

This device complies with Industry Canada RSS-247 ISSUE1 standards. Operation is subject to the following two conditions:

- (1) this device may not cause interference, and
- (2) this device must accept any interference, including interference that may cause undesired operation of the device.

Le présent appareil est conforme aux CNR d'Industrie Canada applicables aux appareils radio exempts de licence. L'exploitation est autorisée aux deux conditions suivantes: (1) l'appareil ne doit pas produire de brouillage, et

- (2) l'utilisateur de l'appareil doit accepter tout brouillage radioélectrique subi, même si le brouillage est susceptible d'en compromettre le fonctionnement.

#### IC Radiation Exposure Statement:

This equipment complies with IC RSS-102 radiation exposure limit set forth for an uncontrolled environment. This equipment should be installed and operated with minimum distance 0.5 cm between the radiator and your body.

Cet équipement est conforme aux CNR-102 d'Industrie Canada. Cet équipement doit être installé et utilisé avec une distance minimale de 20 centimètres entre le radiateur et votre corps. Cet émetteur ne doit pas être co-localisées ou opérant en conjonction avec autre antenne ou émetteur. Les antennes utilisées pour cet émetteur doivent être installés et fournir une distance de séparation d'au moins 0,5 centimètre de toute personne et doit pas être co-située ni fonctionner en conjonction avec une autre antenne ou émetteur.

#### MR-24

##### IC

This device complies with Industry Canada licence-exempt RSS-GEN standards. Operation is subject to the following two conditions:

- (1) this device may not cause interference, and
- (2) this device must accept any interference, including interference that may cause undesired operation of the device.

Le présent appareil est conforme aux CNR d'Industrie Canada applicables aux appareils radio exempts de licence. L'exploitation est autorisée aux deux conditions suivantes :

- (1) l'appareil ne doit pas produire de brouillage, et
  - (2) l'utilisateur de l'appareil doit accepter tout brouillage radio électrique subi, même si le brouillage est susceptible d'en compromettre le fonctionnement.
-

## WARNING

### 1. FOR OUTDOOR USE:

To reduce the risk of fire or electric shock, do not expose this apparatus to rain or moisture.

### 2. UNDER WET LOCATION:

Apparatus should not be exposed to dripping or splashing and no objects filled with liquids, such as vases should be placed on the apparatus.

### 3. SERVICE INSTRUCTIONS:

**CAUTION** - These servicing instructions are for use by qualified service personnel only. To reduce the risk of electric shock, do not perform any servicing other than that contained in the operating instructions unless you are qualified to do so.



 This symbol indicates that dangerous voltage constituting a risk of electric shock is present within this unit.

 This symbol indicates that there are important operating and maintenance instructions in the literature accompanying this unit.

### **Disposal**



2005-08-13

Dispose of any unusable devices or batteries responsibly and in accordance with any applicable regulations.

Disposing of used batteries with domestic waste is to be avoided!

Batteries / NiCad cells often contain heavy metals such as cadmium (Cd), mercury (Hg) and lead (Pb) that makes them unsuitable for disposal with domestic waste. You may return spent batteries/ accumulators free of charge to recycling centres or anywhere else batteries/accumulators are sold.

By doing so, you contribute to the conservation of our environment!

---

# I. Wireless Electric Guitar / Electric Bass Set: MR-24GE / MT-24GE

## 1. Pedal Receiver Part Names:

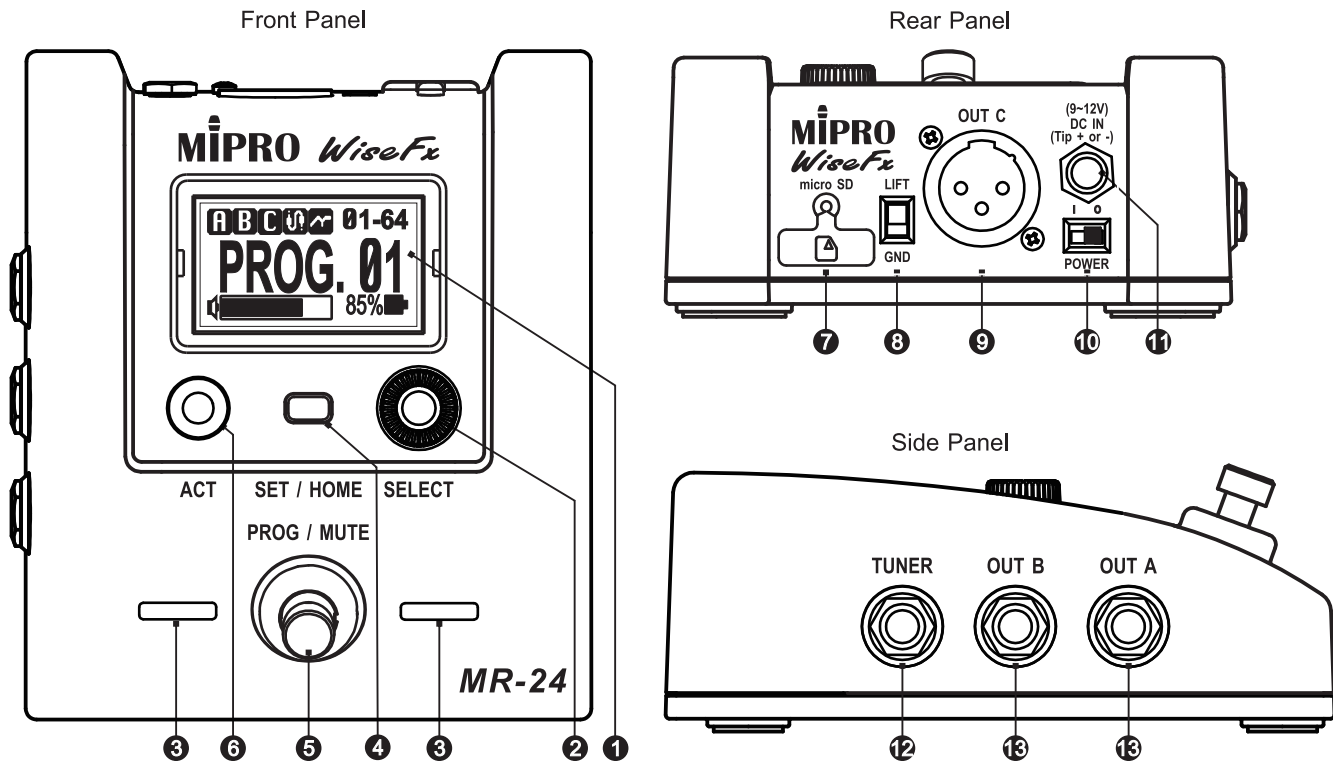

Fig. 1

- ❶ LCD screen.
- ❷ SELECT parameter rotary knob.
- ❸ Programmed Identification LED Indicators.
- ❹ SET | HOME parameter button.
- ❺ PROG | MUTE footswitch.
- ❻ Channel sync ACT button.
- ❼ Micro SD Card slot for user programming and firmware updates.
- ❽ Pin 1 of the Out C ❾ XLR connector ground or lift setting switch.
- ❿ Output C balanced XLR connector.
- ⓫ Power Switch.
- ⓬ 9 ~ 12V DC power input jack.
- ⓭ TUNER unbalanced output 6.3 Ø phone jack.
- ⓮ Outputs A & B unbalanced output 6.3 Ø phone jack.



## 2. Receiver Installation:

### (A) Outputs to amplifier hookup, Fig. 2:

Use the cable with both 6.3 Ø phone jacks to connect the receiver outputs 12 13 to tuner, multi-effects and guitar amplifier inputs.

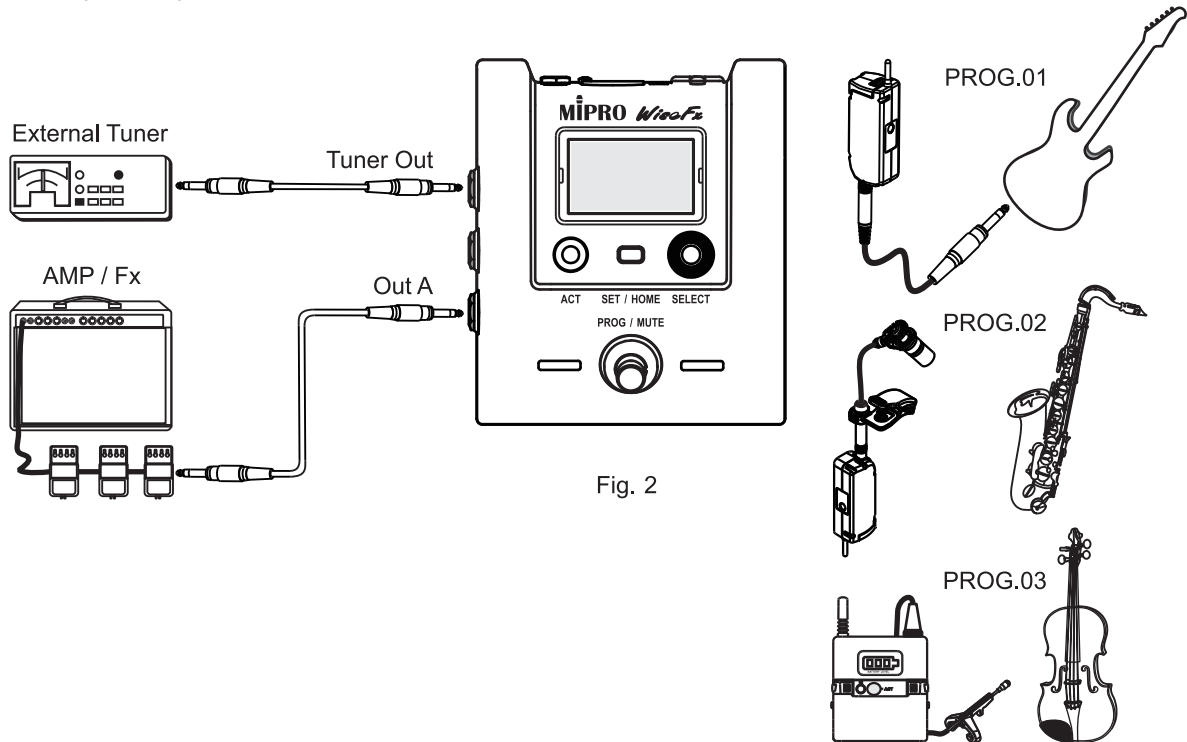
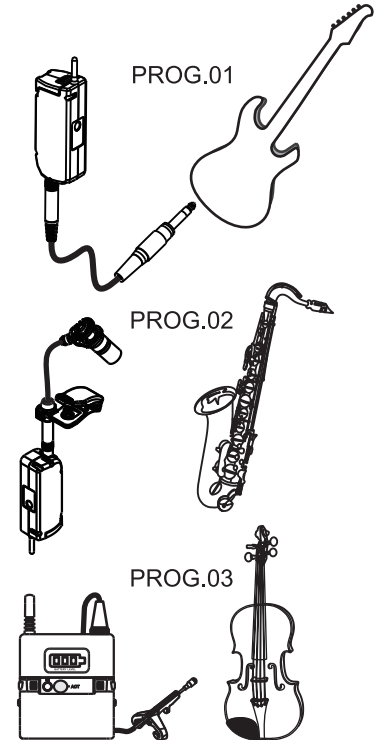
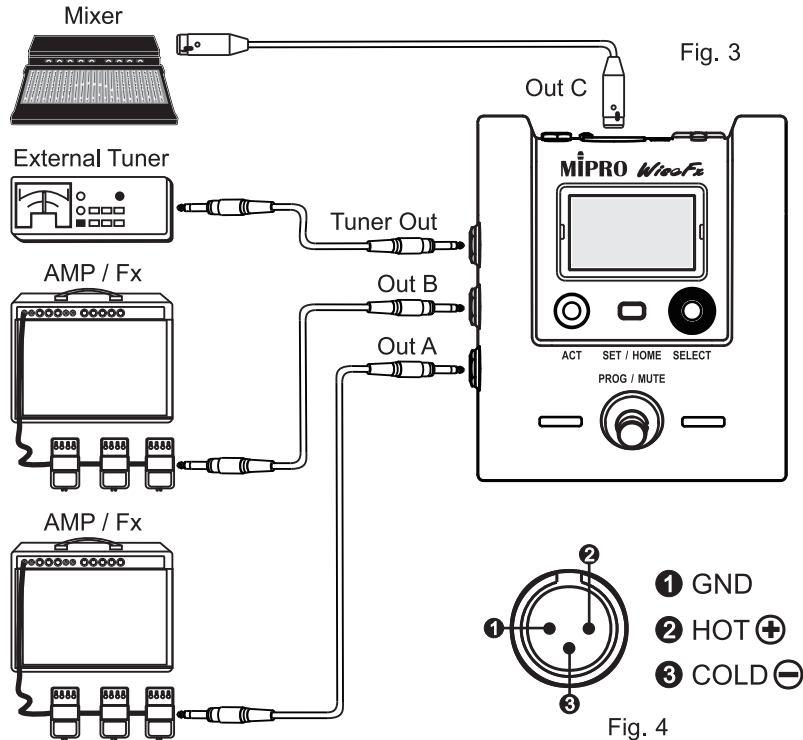

Fig. 2

(B) Outputs to multi-system hookup, Fig. 3:

Connect XLR balanced connector from receiver Output C ⑨ to mixer or amplifier balanced input.

Connect 6.3 Ø to 6.3 Ø phone jack cables from receiver outputs ⑫ ⑬ to tuner and guitar amplifier inputs, Fig. 3. Receiver 3-pin balanced output wiring connection, Fig. 4.



### 3. Operating Instructions:

#### (A) Power Supply Installation, Fig. 5:

Connect DC power supply to receiver DC Input Jack **11** and plug the power cord into an AC power outlet.

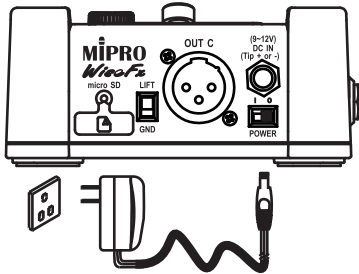

Fig. 5

#### (B) Power On, Fig. 6:

Ensure all transmitters are turned off and the mixer's volume control is set to a minimized setting before the receiver is turned on. Once power is connected, set power switch **1** to ON position. LCD display **10** and LED indicators **3** are lit. LCD screen displays the preset start display.

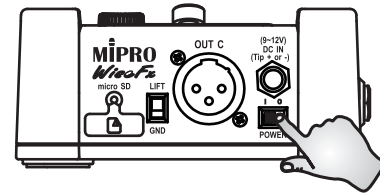

Fig. 6

#### (C) Preset Start Display, Fig. 7:



Fig. 7

(D) Powered-On Display on screen, Fig. 8:

When the transmitter is powered on and channel is synced with receiver, the receiver screen will display transmitter battery level & AF level corresponding to guitar output. If the transmitter is powered off, but the battery level & AF level is displayed, it indicates the transmitter channel or ID is not set up properly. Must select a different channel and press ACT channel sync button again to solve this problem.



Fig. 8

(E) Volume Adjustment:

Transmitter has no volume control, therefore, the volume needs to be adjusted at the gain control function in MR-24 receiver.

#### 4. Panel Operating Instructions:

(A) LCD displays parameters, Fig. 9:

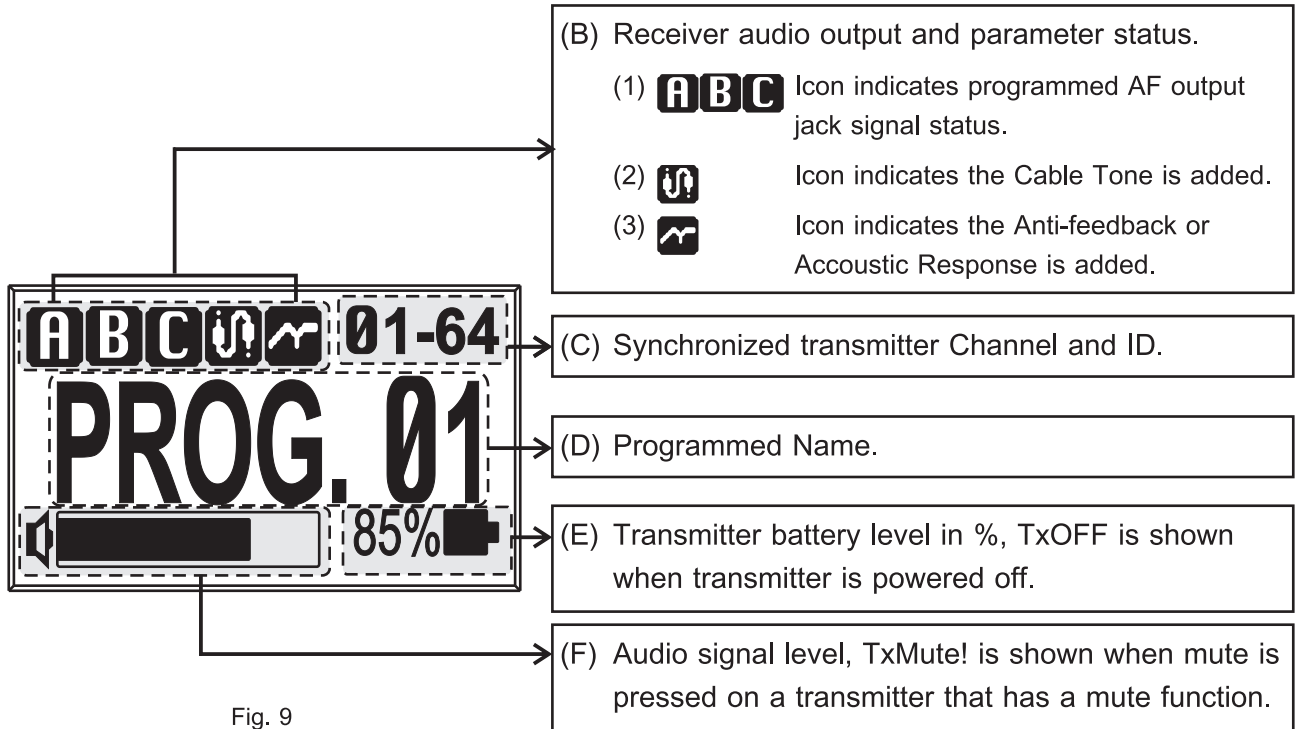

Fig. 9

## 5. Rotary Control Knob Operating Instructions:

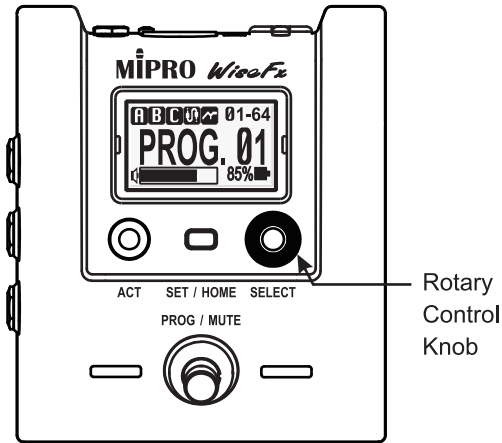



Fig. 10

(A) A navigation control for programming selection, Fig. 10:

- (1) At the primary screen, turn right or left to select prestored programs.
- (2) At the primary screen, press SET / HOME  to enter function setting screen.
- (3) At the primary screen, turn the knob to choose a selection, press again to activate the current selection. Rotate to choose a new selection, and press the knob to store. Press SET / HOME button again to return to primary screen.

(B) Function Setting Sequence Screen, Fig. 11:

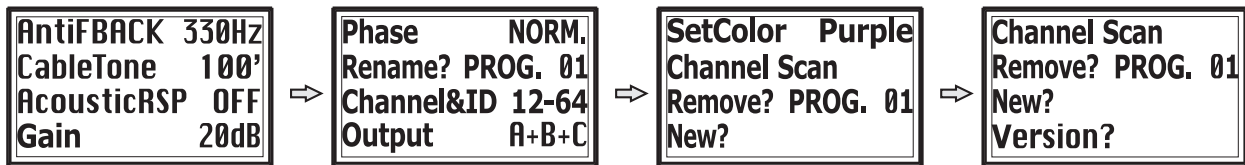



Fig. 11

(C) Rotary Control Knob Operating Instructions:

- (1)  Press the rotary knob.



- (2)  Turn the rotary knob right or left.



(D) AntiFBACK ( Anti Feedback ) function, Fig. 12:

When feedback is resulted from speaker system, ANTiFBACK can be selected 31 different feedback frequencies to suppress most of the annoying feedback or OFF.

AntiFBACK 330Hz	←	AntiFBACK OFF
CableTone 100'	↻	CableTone 100'
AcousticRSP OFF	↻	AcousticRSP OFF
Gain 20dB	↻	Gain 20dB

Fig. 12

(E) CableTone function, Fig. 13:

Imitates the CableTone features of electric guitar using the cable with length varying 1 ~ 30 meters. Cable Tone can be selected 14 different lengths or OFF.

AntiFBACK 330Hz	←	AntiFBACK OFF
CableTone 100'	↻	CableTone OFF
AcousticRSP OFF	↻	AcousticRSP OFF
Gain 20dB	↻	Gain 20dB

Fig. 13

(F) AcousticRSP ( Acoustic Response ) function, Fig. 14:

When acoustic signal of a guitar is picked through microphone or electronic pickup, it produces excessive resonance, affects sound clarity, or excessive low frequency range resonance. AcousticRSP can be selected 31 loudness controls to adjust and modify for better resonance quality or OFF.

AntiFBACK 330Hz	←	AntiFBACK OFF
CableTone 100'	↻	CableTone OFF
AcousticRSP OFF	↻	AcousticRSP 25
Gain 20dB	↻	Gain 20dB

Fig. 14

(G) Gain control function, Fig. 15:

-10 to 20 dB output volume adjustment in 1dB increase or decrease step increment.

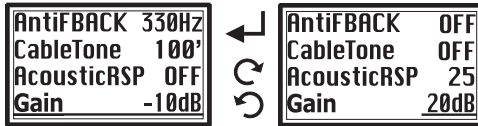

Fig. 15

(H) Phase function, Fig. 16:

The output phase can be selected Normal or Inverse.

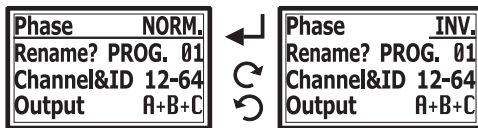

Fig. 16

(I) Rename ? function, Fig. 17:

Rename can be modified up to 8 alphanumeric characters for a programmed name.

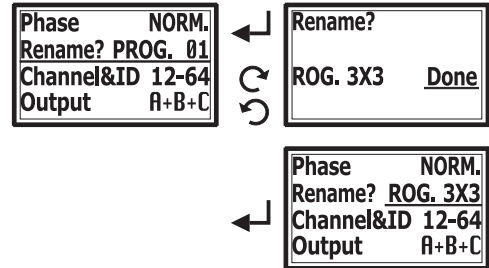

Fig. 17

(J) CHANNEL and ID function, Fig. 18:

Channel and ID provides 12 Channels and 64 ID can be selected.

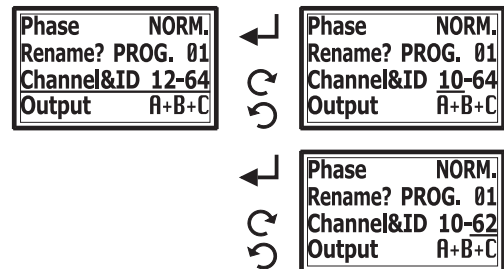

Fig. 18



(K) Output function, Fig. 19:

Programmable A, B, C connector outputs can be turned on or off, respectively.

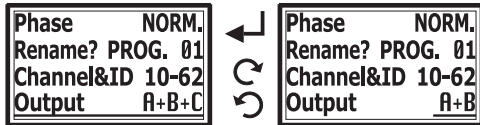

Fig. 19

(L) SetColor function, Fig. 20:

LED Color can be selected up to 8 different colors for fast and easy identification of different programs.

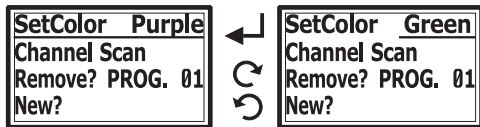

Fig. 20

(M) Channel Scan function, Fig. 21:

Press Channel Scan button to scan the environment for RF field strength to select the best available channel. Turn the knob to a new channel and press to store on the primary screen.

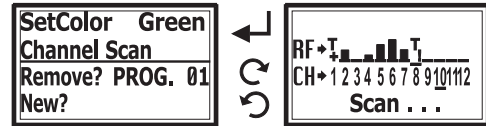

Fig. 21

CAUTION:

- (1) Icon "T+" displays current working transmitter.
- (2) Icon "T|" displays channel occupied by other MIPRO working transmitter.
- (3) Icon "█" displays a severe interference channel.
- (4) Icon "■" displays a lesser interference channel.
- (5) Icon "10" indicates the current selected channel.

(N) Remove ? function, Fig. 22:

The programmed names can be deleted except the default setting PROG. 01 name.

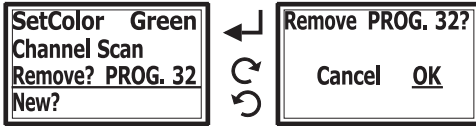

Fig. 22

(O) Add a new program name, Fig. 23:

New program name can be stored up to 32 different names. The default setting is PROG. 01.

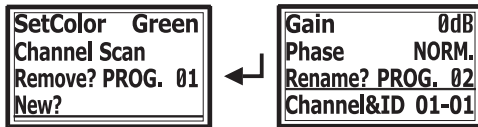

Fig. 23

(P) Software version, Fig. 24:

Indicates the receiver software version. The version may be renewed.



Fig. 24

(Q) Transmitter Battery Meter (receiver display):

- (1) The battery meter displays in percentage in receiver illuminates when transmitter is powered on. Recharge the transmitter battery (or replace with a charged battery pack) immediately when battery indicators fall to 10% showing.
- (2) TxOFF is shown when transmitter is powered off, Fig. 25.



Fig. 25

(R) ACT Channel Sync Operating Instructions,

Fig. 26:

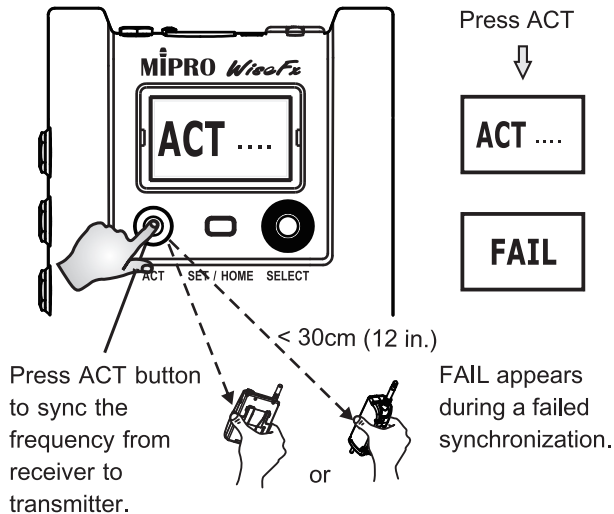

Fig. 26

- (1) Turn on the transmitter. Press ACT button on the receiver. The word [ ACT ---] appears and starts flashing to denote synchronization is now activated and sync is in progress. If no signal is received for over 40 seconds, the word [ FAIL ] appears. Repeat by pressing the ACT button again.

- (2) Align the ACT sync windows of both transmitter and receiver within 30cm.
- (3) Once synchronization is complete and successful the display returns to the main menu. If synchronization is not complete and not successful, the word FAIL appears in about 10 seconds and the display returns to the main menu. If failed, repeat the sync procedure, carefully maintain alignment between the ACT sync windows of both transmitter and receiver.

## 6. CAUTION:

- (A) Position the receiver at least 5-meter away from WiFi, Bluetooth or other 2.4 GHz transmitting devices.
- (B) Line-of-sight between the transmitter and receiver provides the ideal reception range.
- (C) Power supply voltage should not be less than 9V and not higher than 12V. Ensure at least DC 300mA. Deficient supply voltage causes instable operating or malfunction and exceeding supply voltage causes shorter the product life cycle and possible short or damaging circuits.
- (D) User can scan environment for WiFi devices with smartphone app, normally WiFi channel selections are 1, 6, 11.
  - (1) When there is WiFi channel selection 1, receiver channels can be set at 01 and 10 for non-interfering channels. Or select a lesser interference channels like 02, 03, 04, 05, 06, 07, 08, 09.
  - (2) When there is WiFi channel selection 6, receiver channels can be set at 01 and 11 for non-interfering channels. Or select a lesser interference channels like 02, 03, 04, 05, 06, 07.
  - (3) When there is WiFi channel selection 11, receiver channels can be set at 01 and 12 for non-interfering channels. Or select a lesser interference channels like 02, 03, 04, 05, 06, 07, 08, 09.

(H) Wi-Fi Channel Distribution, Fig. 27:

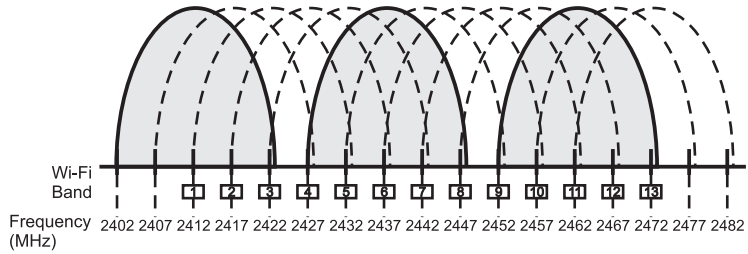

Fig. 27

## 7. Transmitter Part Names:

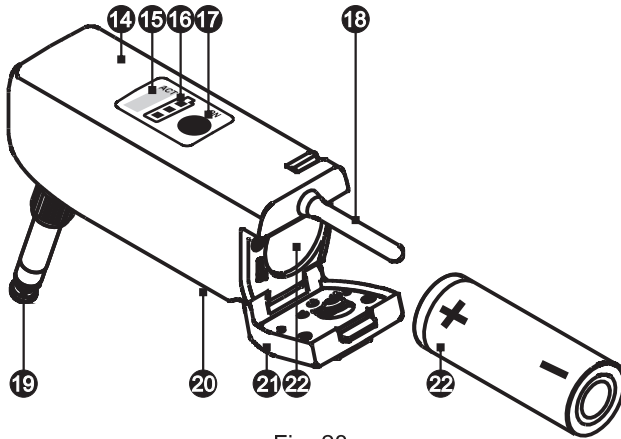

Fig. 28

- 14 Housing.
- 15 ACT Sync Port.
- 16 Battery Level Indicators.
- 17 Power button.
- 18 Transmitting Antenna.
- 19 6.3 Ø input phone plug.
- 20 Battery Charging Contacts.
- 21 Battery cover and battery negative pole.

- 22 Battery Compartment and rechargeable battery. Insert plus positive (+) polarity battery towards inside of the compartment.

## 8. Operating Instructions:

- (A) Power on: Press the power button 17 and battery indicators 16 are lit.
- (B) Power off: Press the power button for two seconds and battery indicators are off.
- (C) Battery level indicators, Fig. 29.  
Recommend charging or replace a fully-charged battery when single red indicator remains. Power shutdown automatically when battery voltage is too low.

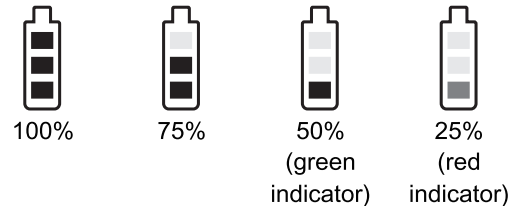
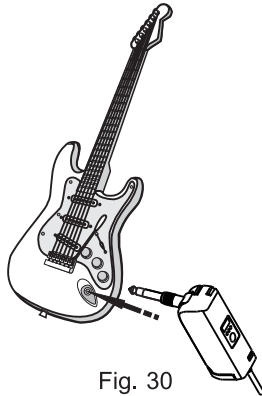
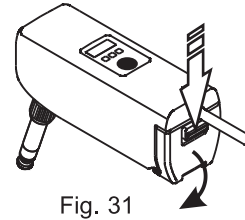

Fig. 29

(D) Plug into any guitar, keyboard or other musical instrument output jack, Fig. 30.



## 9. Battery Insertion and Replacement:



(A) Gently push down on the battery compartment latch and swing the battery compartment over open, Fig. 31.

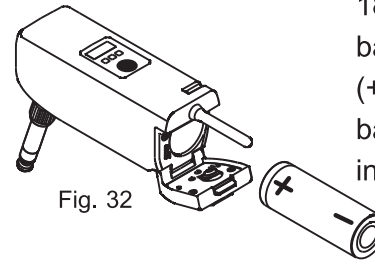

(B) Install a fully-charged 18500 rechargeable battery with positive (+) polarity end of battery towards inside, Fig. 32.

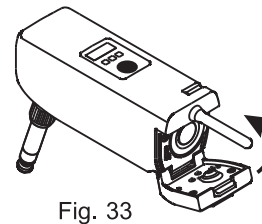

(C) Carefully close the battery cover until the hinge is properly locked and secured, Fig. 33.

- (D) Keep the transmitter power off to preserve battery power after each use. Remove the battery when it will not be used for an extended period of time.

#### 10. MP-24 Charger Usage:

- (A) Insert MT-24 transmitter into the charger. Ascertain the charging contacts are aligned with correct polarity.

- (B) Plug-in both ends as shown in Fig. 34.

- (C) Charging Status: The indicator light displays the charging status of the battery, Fig. 35.

- (1) Still Red: The battery is charging.
- (2) Still Green: The battery is fully charged.
- (3) Light is off: No transmitter is inserted.

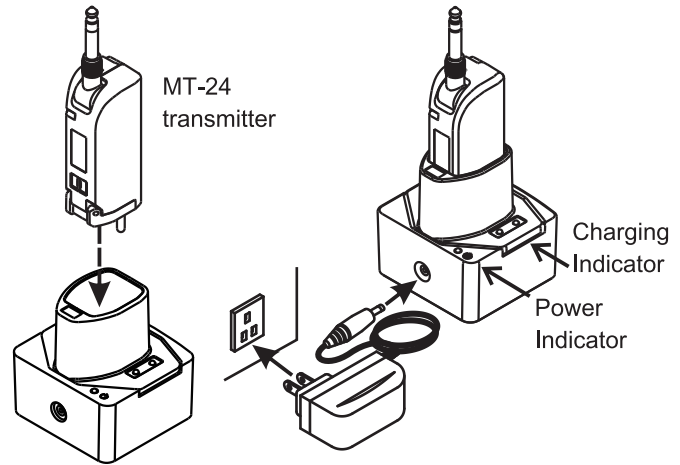

Fig. 34

(transformer is for reference only)

Fig. 35

- (D) Charging Caution:

- (1) Use supplied charger only. Do not use other brands' charger to avoid voltage or current shortage as it can be dangerous. DC power input voltage specified value is 5V / 1A DC.
- (2) Turn off the transmitter power during charging to assure the battery is fully charged.



## 11. Transmitter Installation:

- (A) Remove the 6.3 Ø input phone plug adapter from MT-24, Fig. 36-1.
- (B) Connect the MJ-10E guitar cable to MT-24 and plug the other end to guitar output jack, Fig. 36-2.
- (C) Install the clip on MT-24, Fig. 36-3.
- (D) Clip the transmitter to the guitar strap for a secured fit, Fig. 36-4.



Fig. 36-1

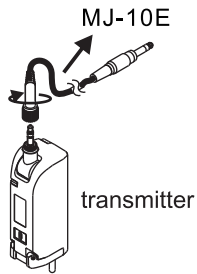

Fig. 36-2

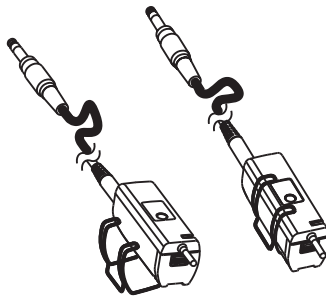

Fig. 36-3



Fig. 36-4

## II. Acoustic Guitar / Ukulele Set: MR-24GA / MT-24GA / MR-24UC / MT-24UC

### 1. Microphone Installation, Fig. 37:

- (A) Loose or detach the strings..
- (B) Clean the dry the top board..
- (C) Remove the back liner and paste the microphone to the top board from the sound hole.

- (D) Set the microphone cable alongside the body with microphone cable holders.
- (E) Fasten the output connector to the bottom hole of acoustic guitar or ukulele.

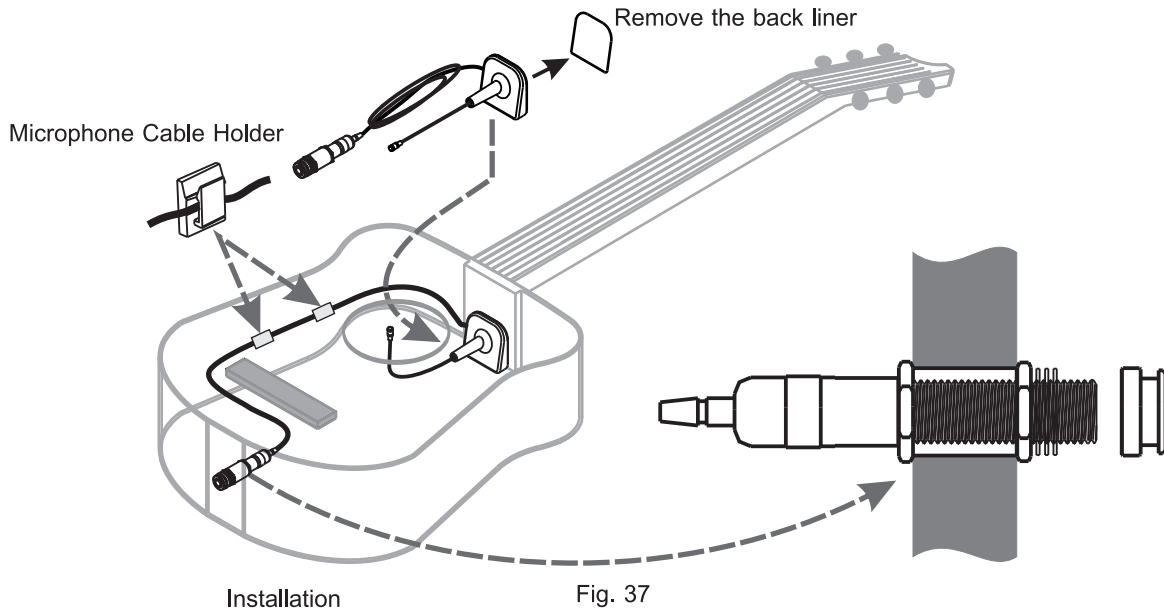

## 2. Transmitter Installation, Fig. 38:

(A) Remove the 6.3 Ø input phone plug adapter from MT-24, Fig. 38-1.

(B) Connect the MJ-10A acoustic guitar cable to MT-24 and plug the other end to guitar output jack, Fig. 38-2.

(C) Install the clip on MT-24, Fig. 38-3.

(D) Clip the transmitter to the acoustic guitar / ukulele strap for a secured fit, Fig. 38-4.

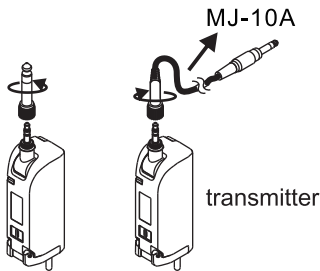

Fig. 38-1 Fig. 38-2

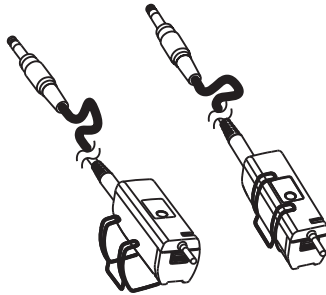

Fig. 38-3  
Fig. 38

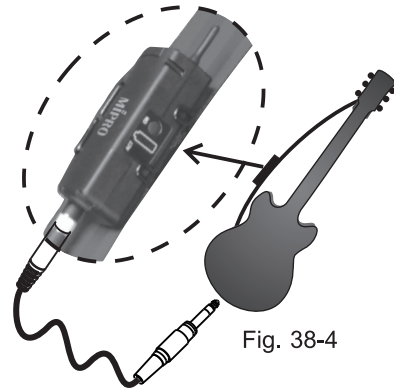
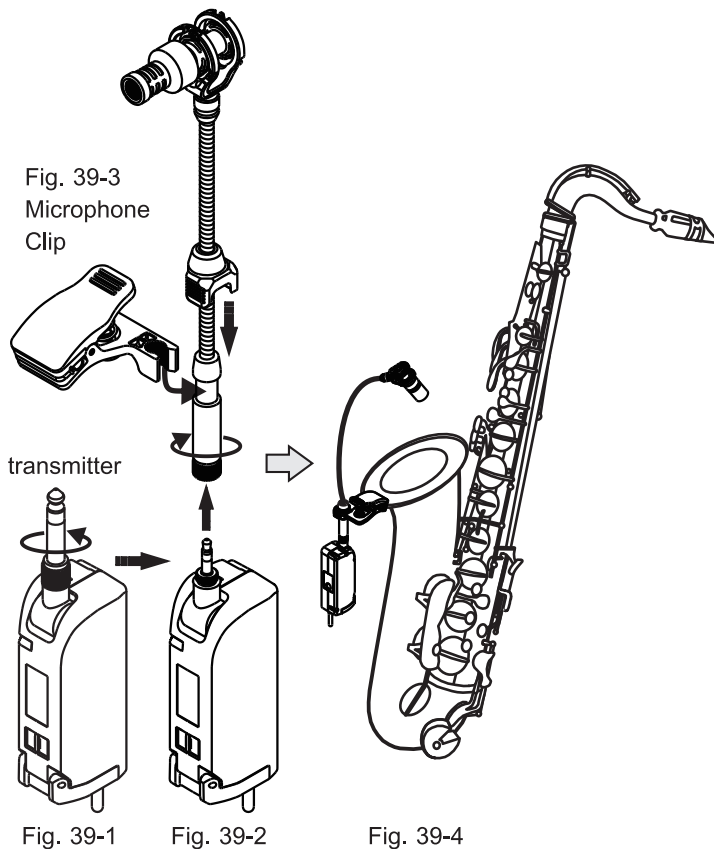

Fig. 38-4

### III. Saxophone Set: MR-24SS / MT-24SS / MR-24SA / MT-24SA / MR-24ST / MT-24ST / MR-24SB / MT-24SB

Transmitter Installation, Fig. 39:

- (A) Remove the 6.3 Ø input phone plug adapter from MT-24, Fig. 39-1.
- (B) Connect and fasten the microphone with MT-24, Fig. 39-2.
- (C) Install the clip on the microphone, Fig. 39-3.
- (D) Clip the transmitter set to the saxophone or wind instrument, Fig. 39-4.



## IV. Cajon Set: MR-24DC / MT-24DC

### Transmitter Installation, Fig. 40:

- (A) Remove the 6.3 Ø input phone plug adapter from MT-24, Fig. 40-1.
- (B) Connect and fasten the microphone with MT-24, Fig. 40-2.
- (C) Install the transmitter bracket on the cajon, Fig. 40-3.
- (D) Fasten the transmitter set to the bracket, Fig. 40-4.

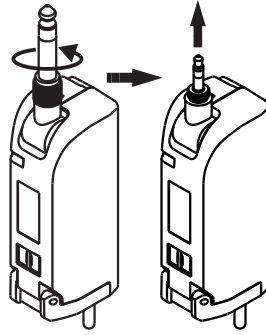

Fig. 40-1

Fig. 40-2

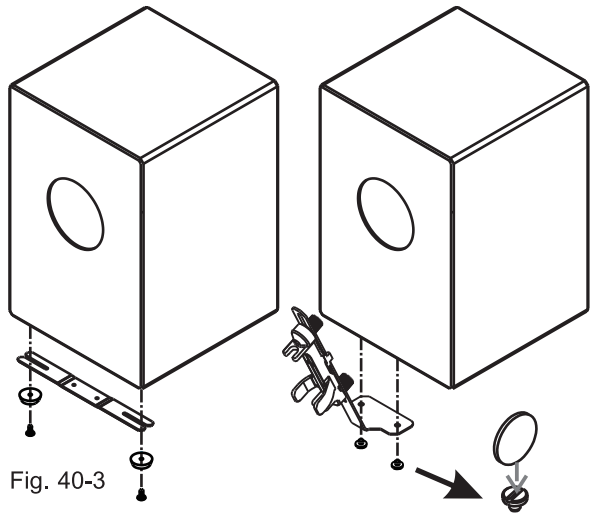
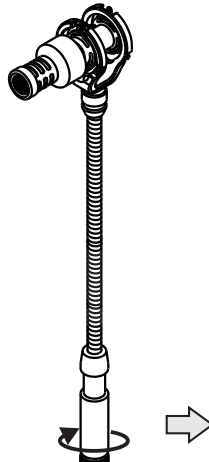

Fig. 40-3

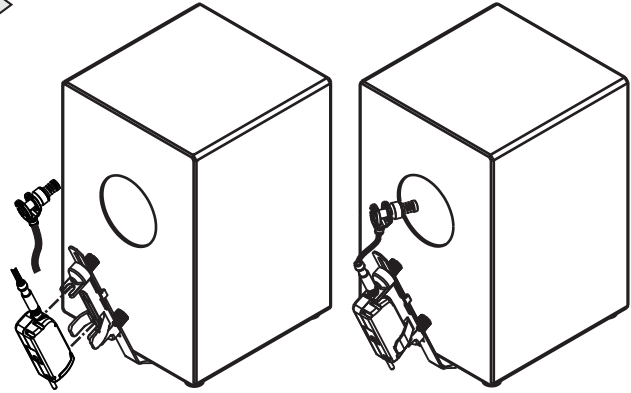

Fig. 40-4

Fig. 40

## V. Note

1. Design and specifications are subject to change without prior notice. Refer to actual product in the event of product discrepancy.
2. Frequency range, output power and maximum deviation to adhere to local telecom regulations.



**MIPRO**<sup>®</sup>  
MICROPHONE PROFESSIONALS

All rights reserved. MN 019/07

Do not copy or forward without prior approvals MIPRO.

Specifications and design subject to change without notice.

**MIPRO Electronics Co., Ltd**

Headquarters: No. 814, Beigang Rd., Chiayi City 60096, Taiwan

Tel : +886.5.238.0809

Fax : +886.5.238.0803

[www.mipro.com.tw](http://www.mipro.com.tw)

[mipro@mipro.com.tw](mailto:mipro@mipro.com.tw)



2002-08-31



2CE600B